

Batterie

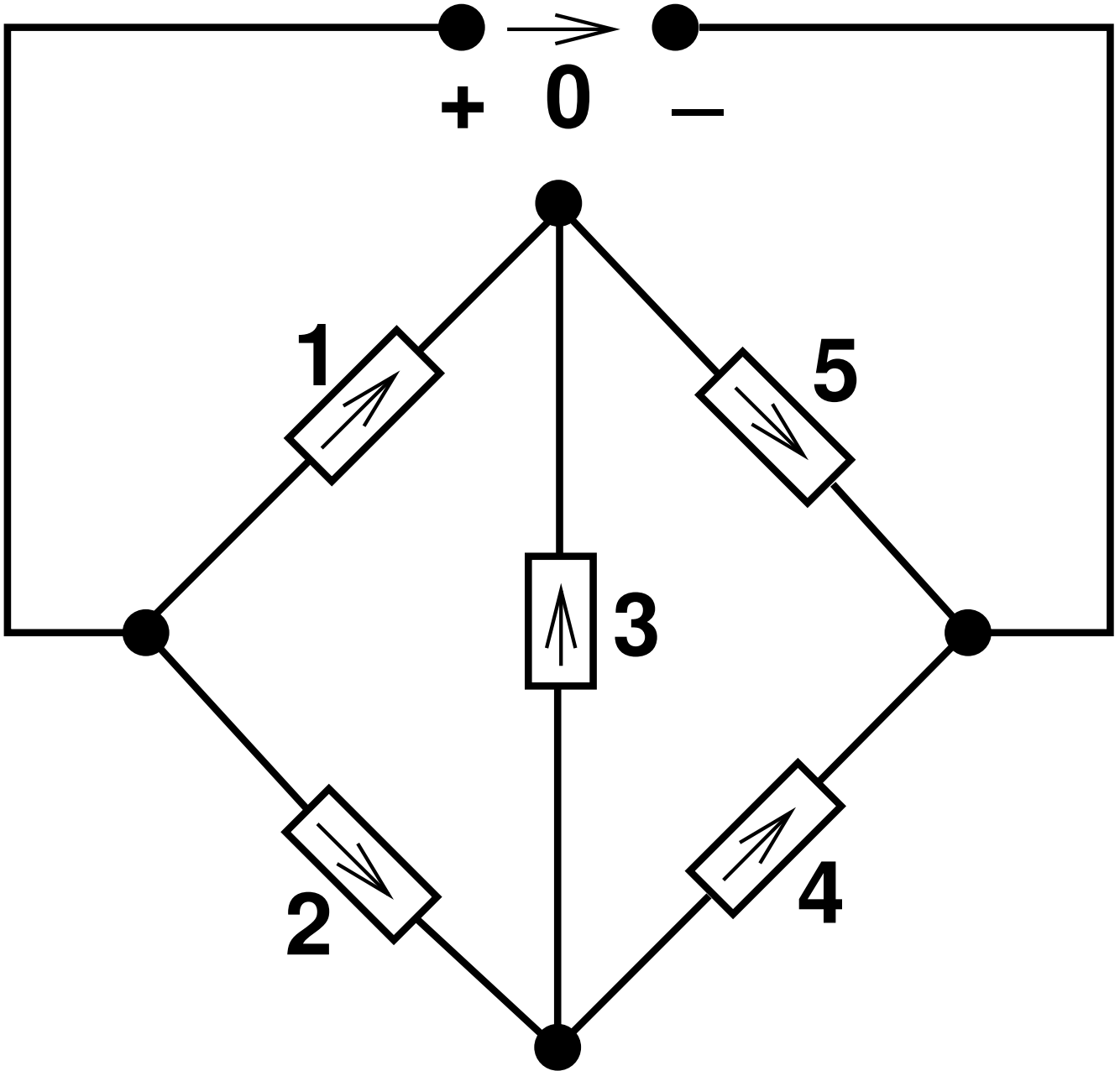

Grafische Veranschaulichung von Lösungsmengen

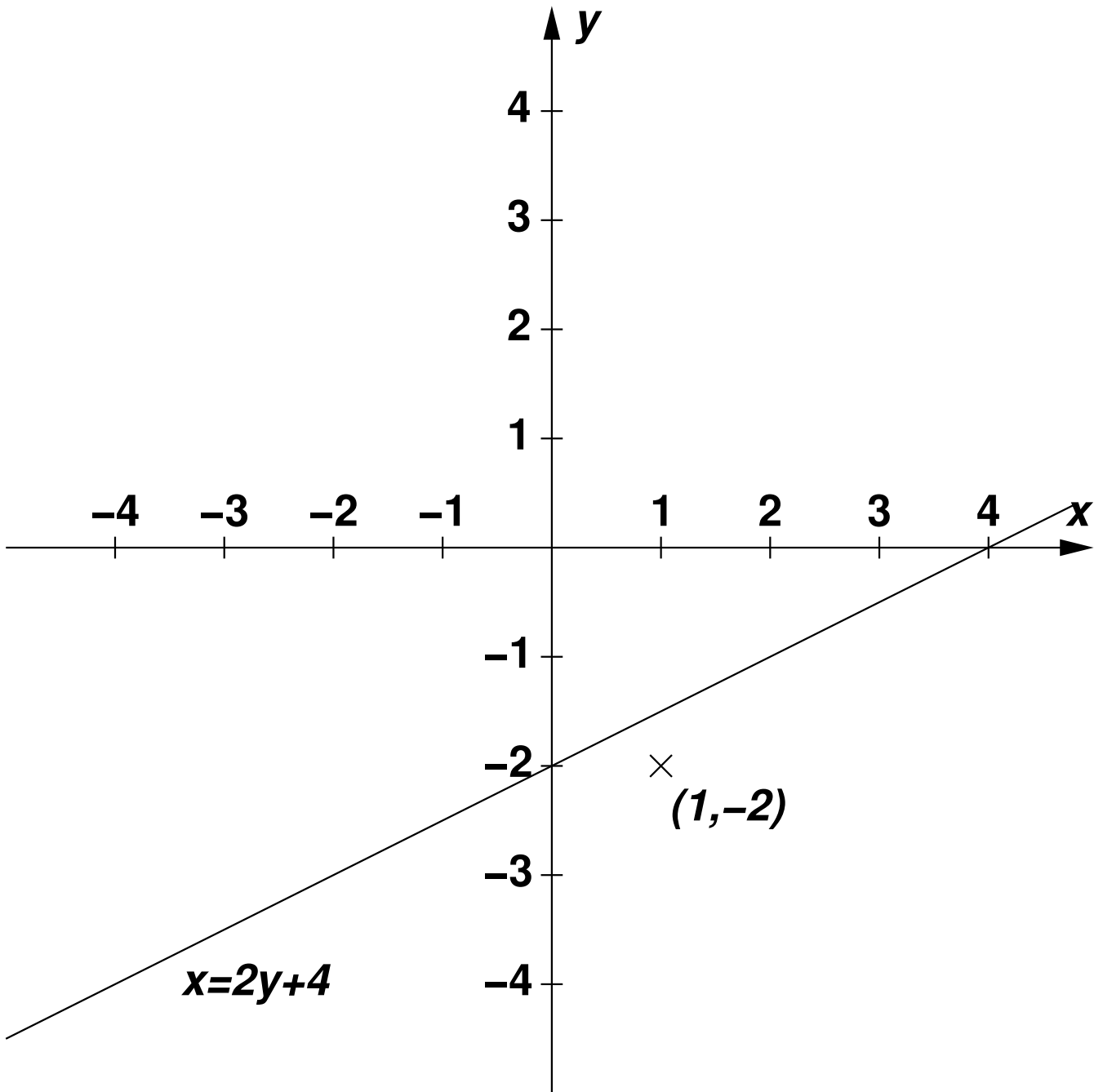

2-dimensionales Koordinatensystem

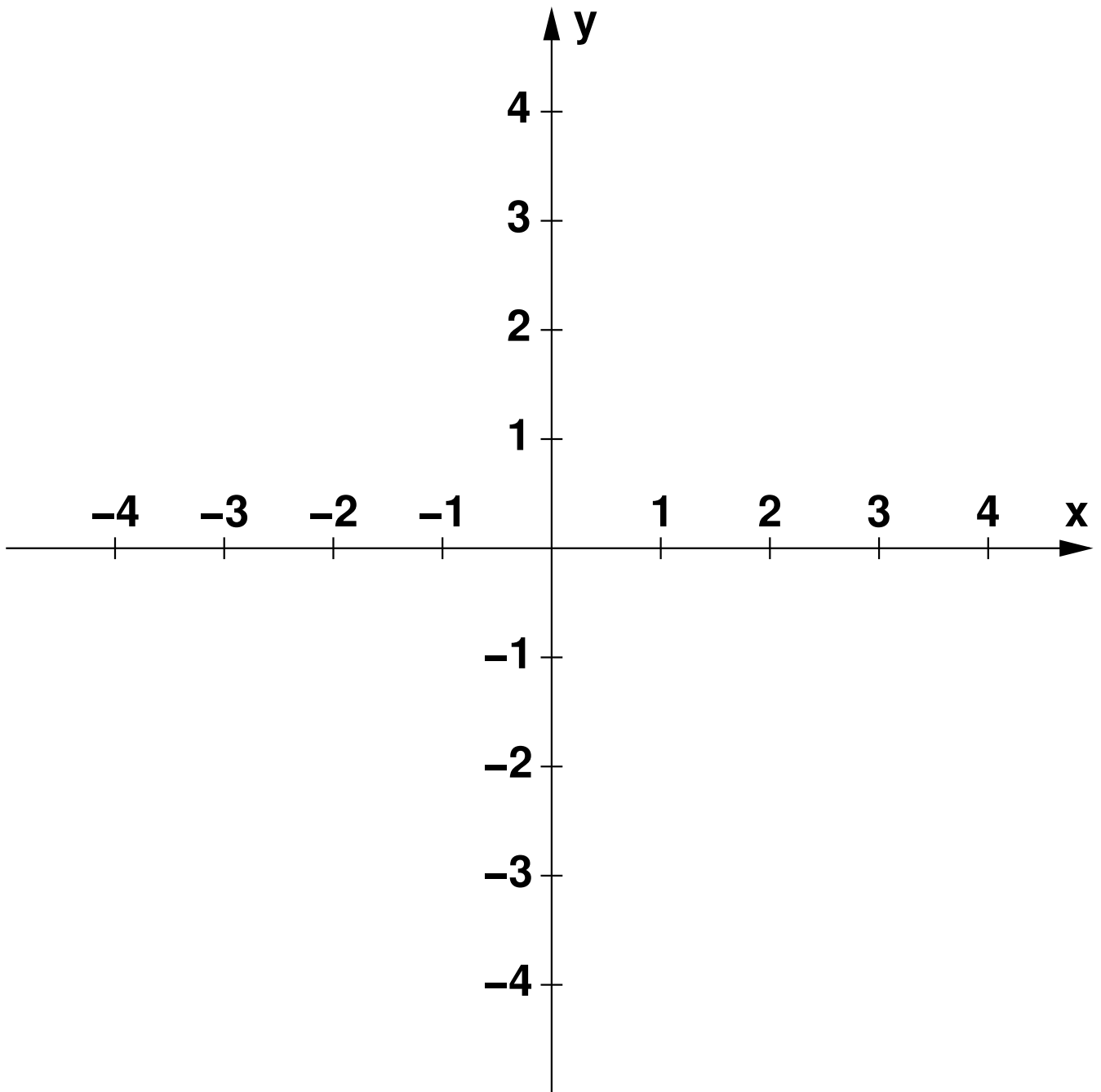

3-dimensionales Koordinatensystem

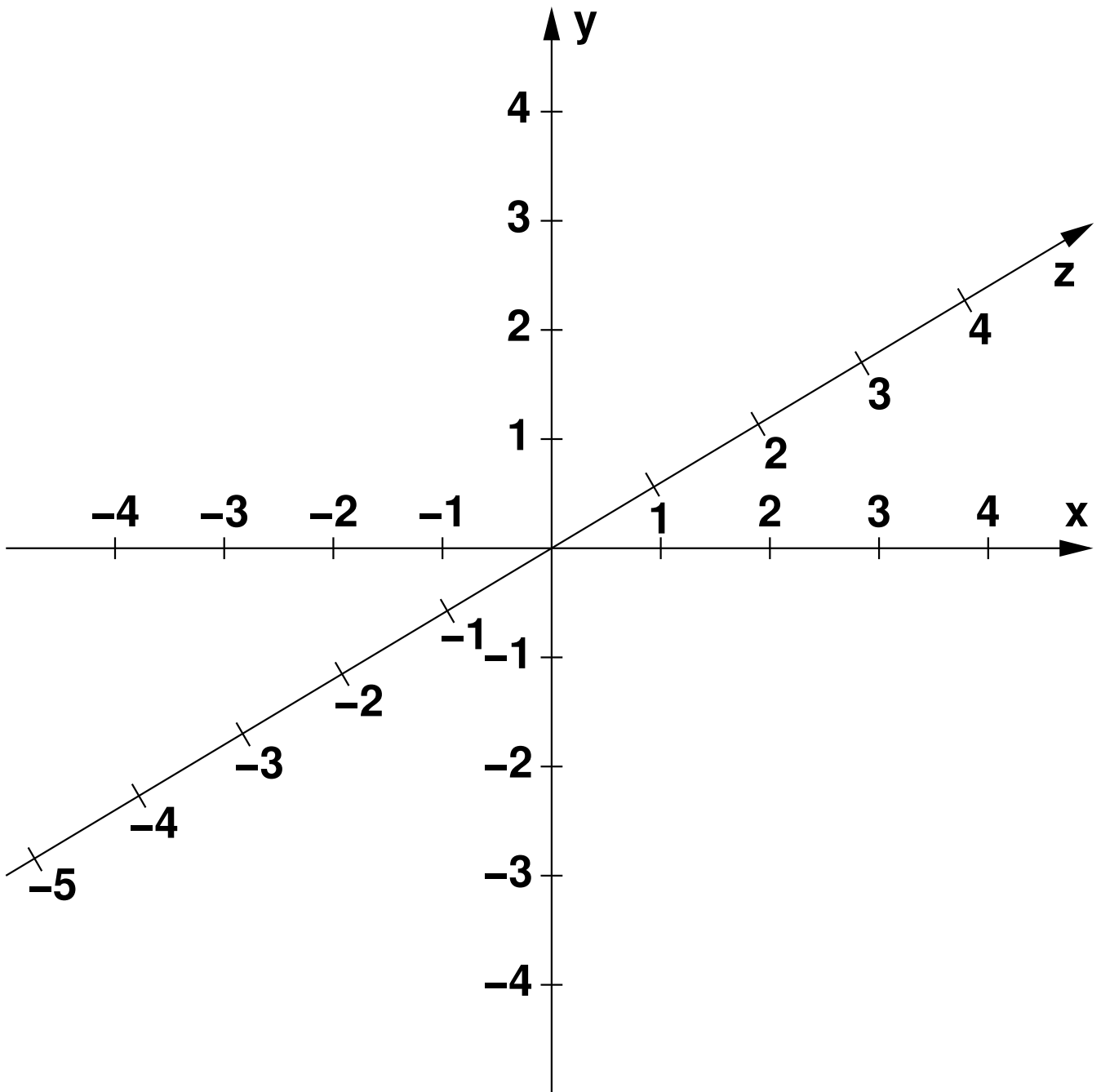

Addition von Vektoren

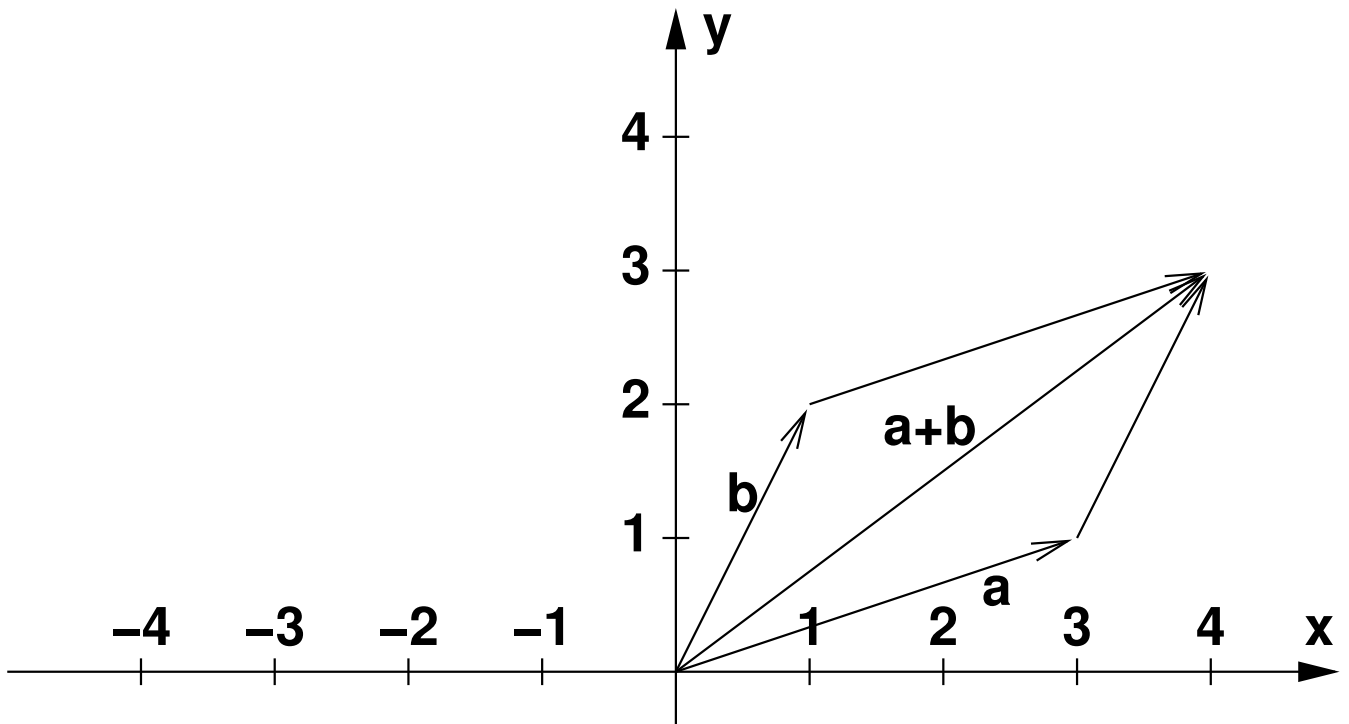

Vielfache von Vektoren

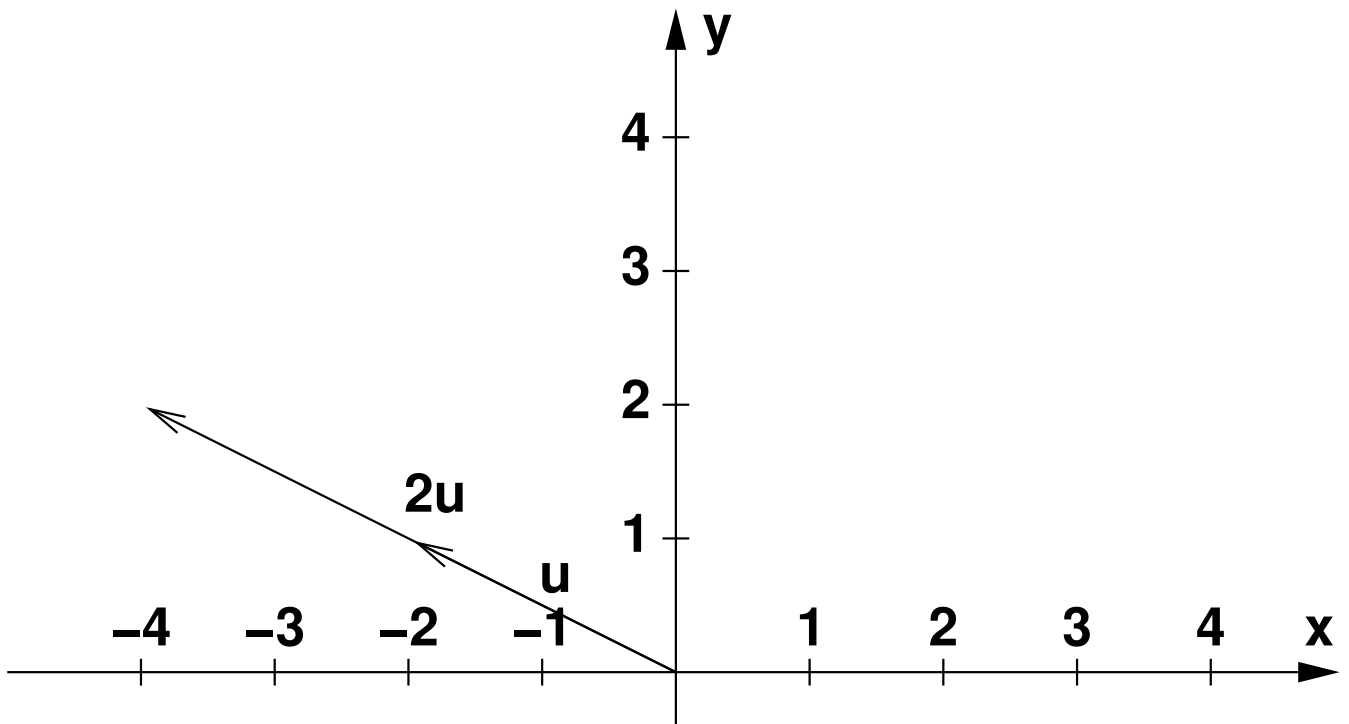

Gerade in Parameterform

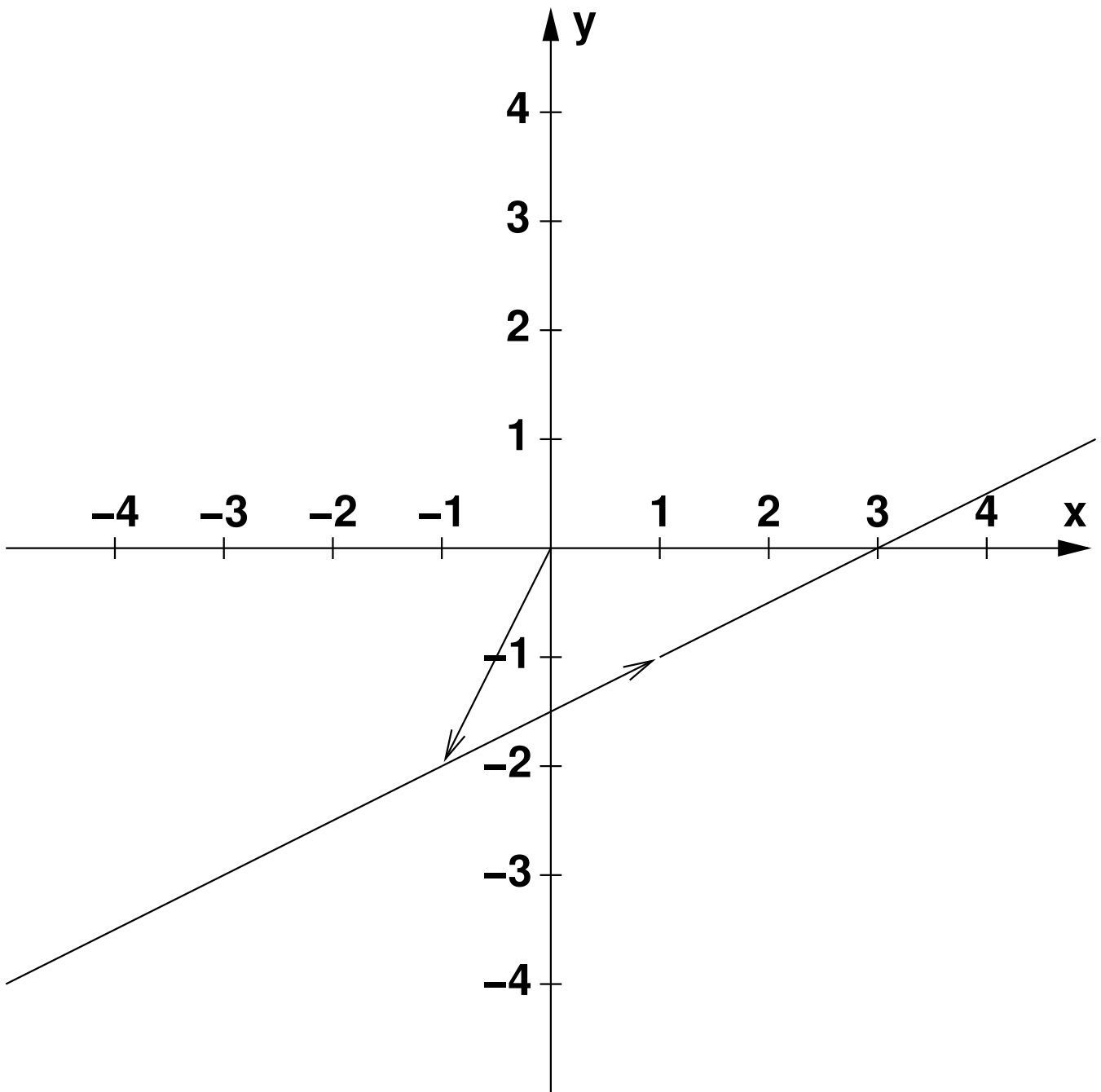

Satz des Pythagoras

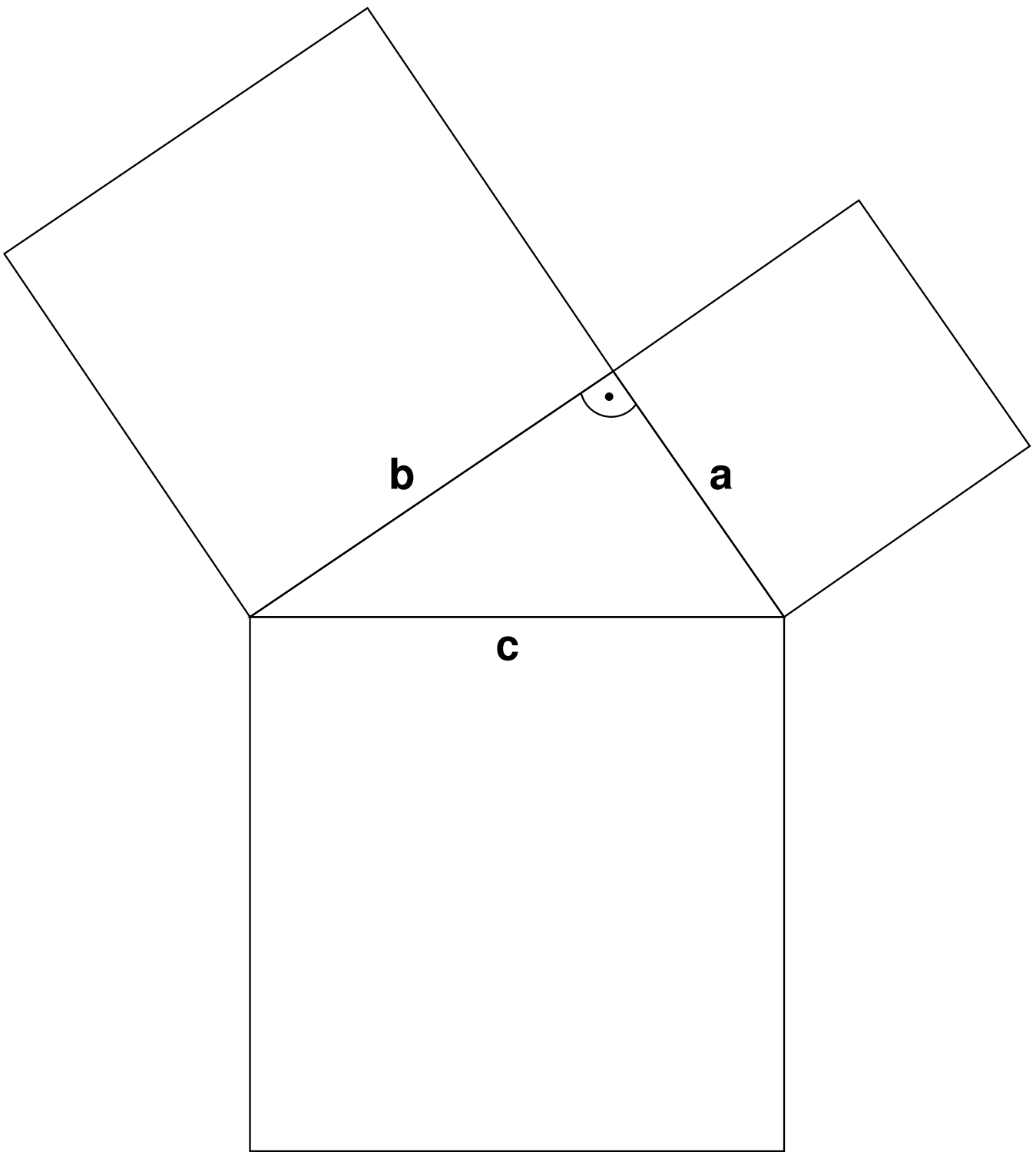

Beweis für Satz des Pythagoras

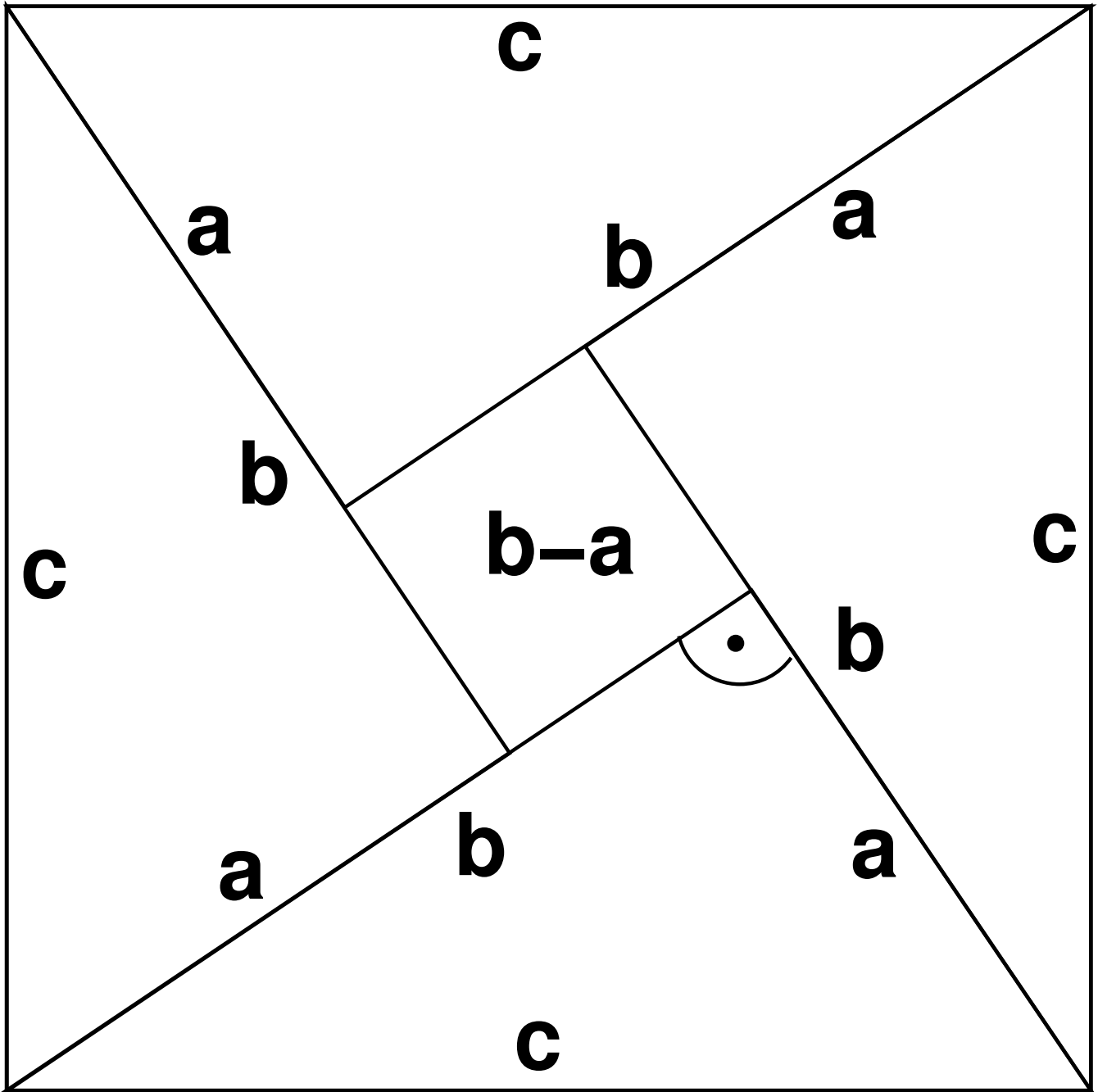

Beweis für die Umkehrung des Satzes des Pythagoras

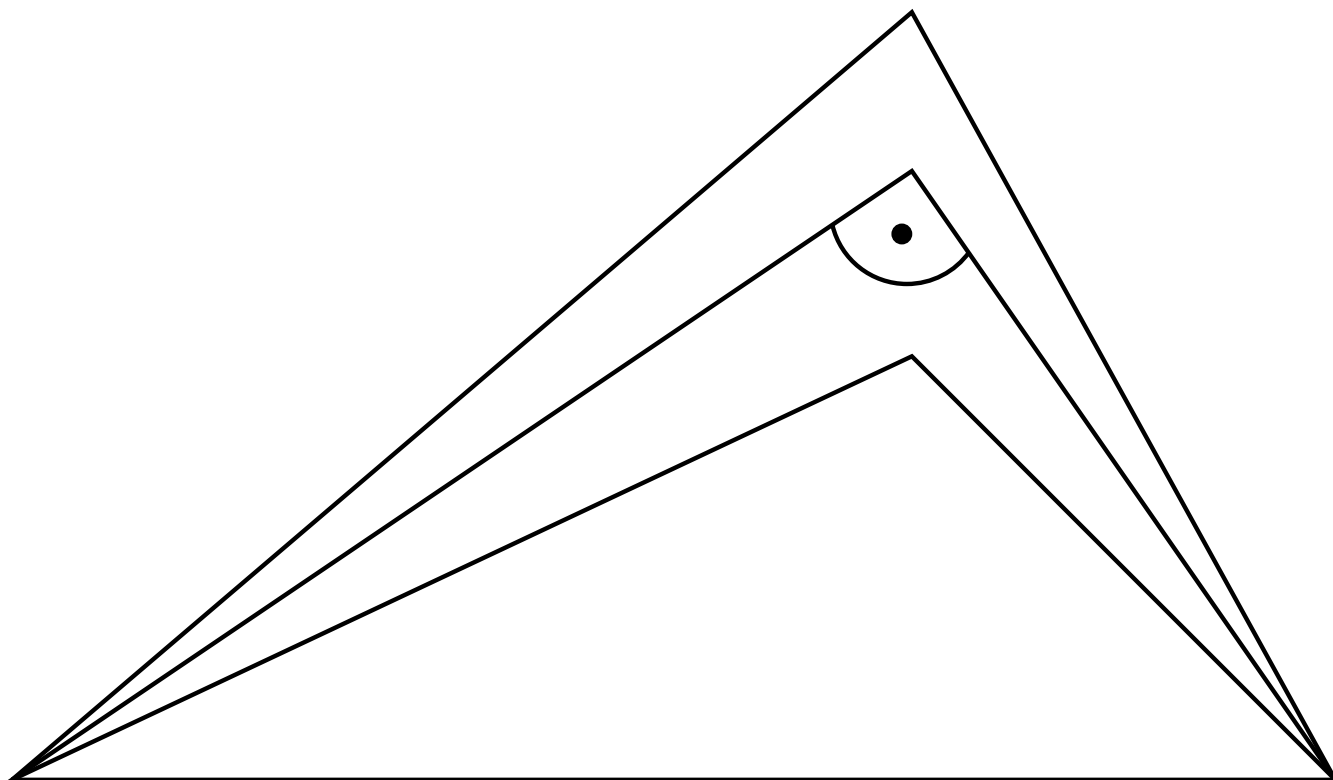

Länge von Vektoren

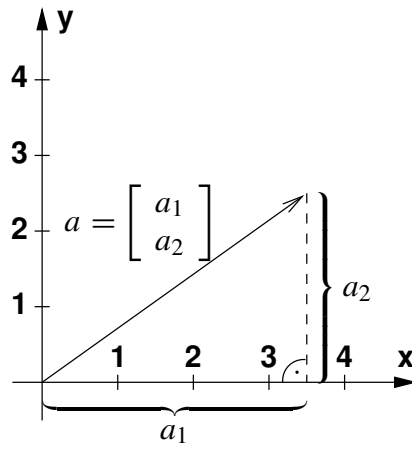

Abstand von Punkten in der Ebene

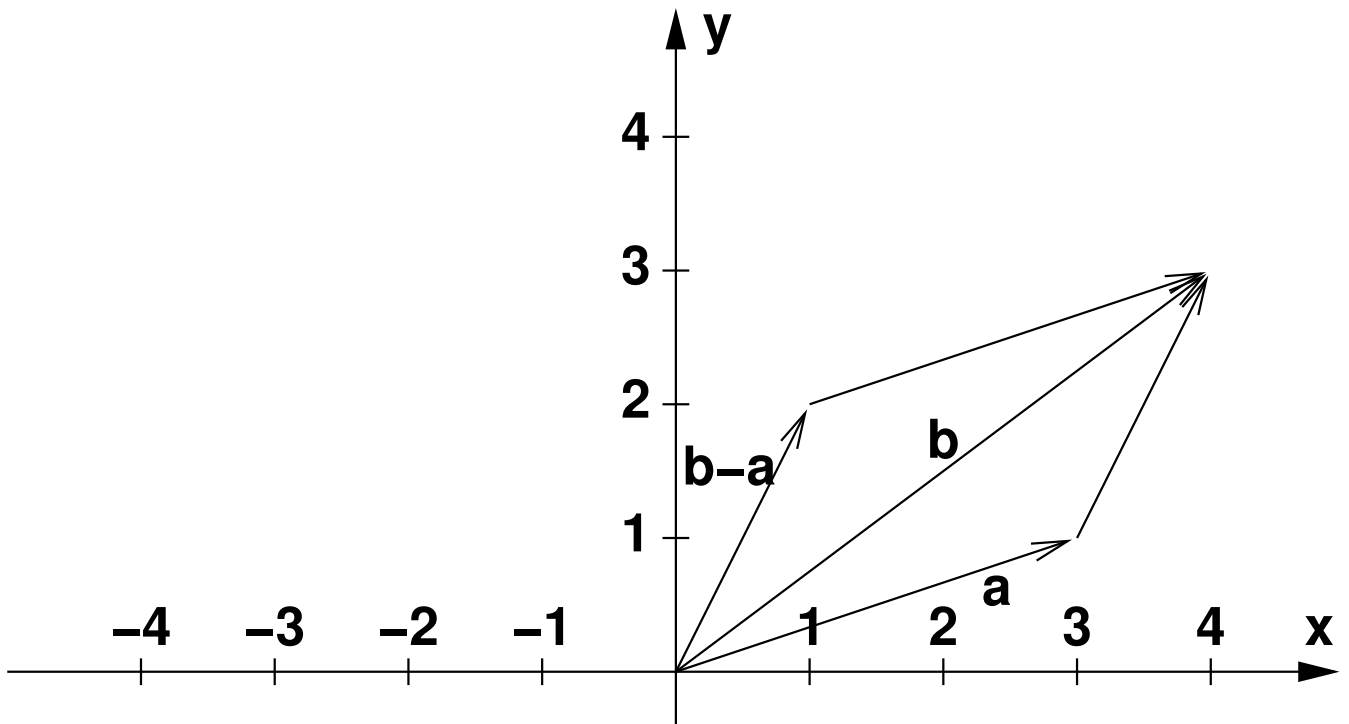

Länge von Vektoren im Raum

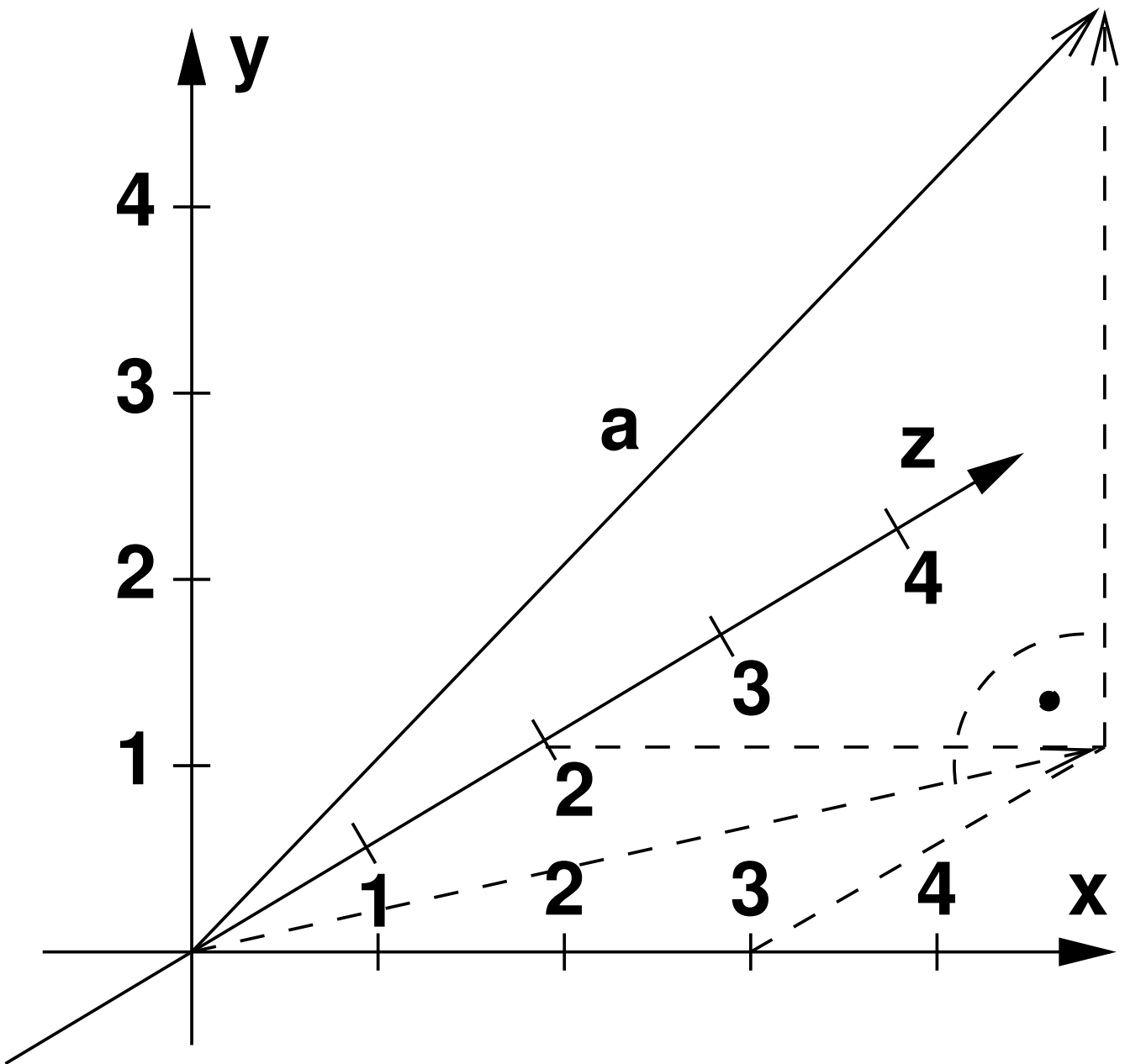

Sinus und Cosinus

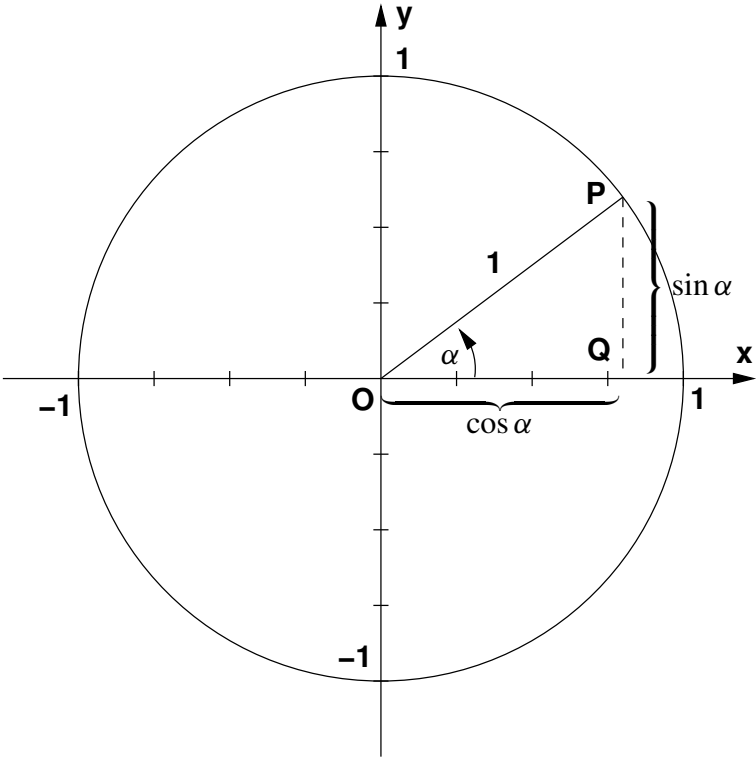

Cosinussatz

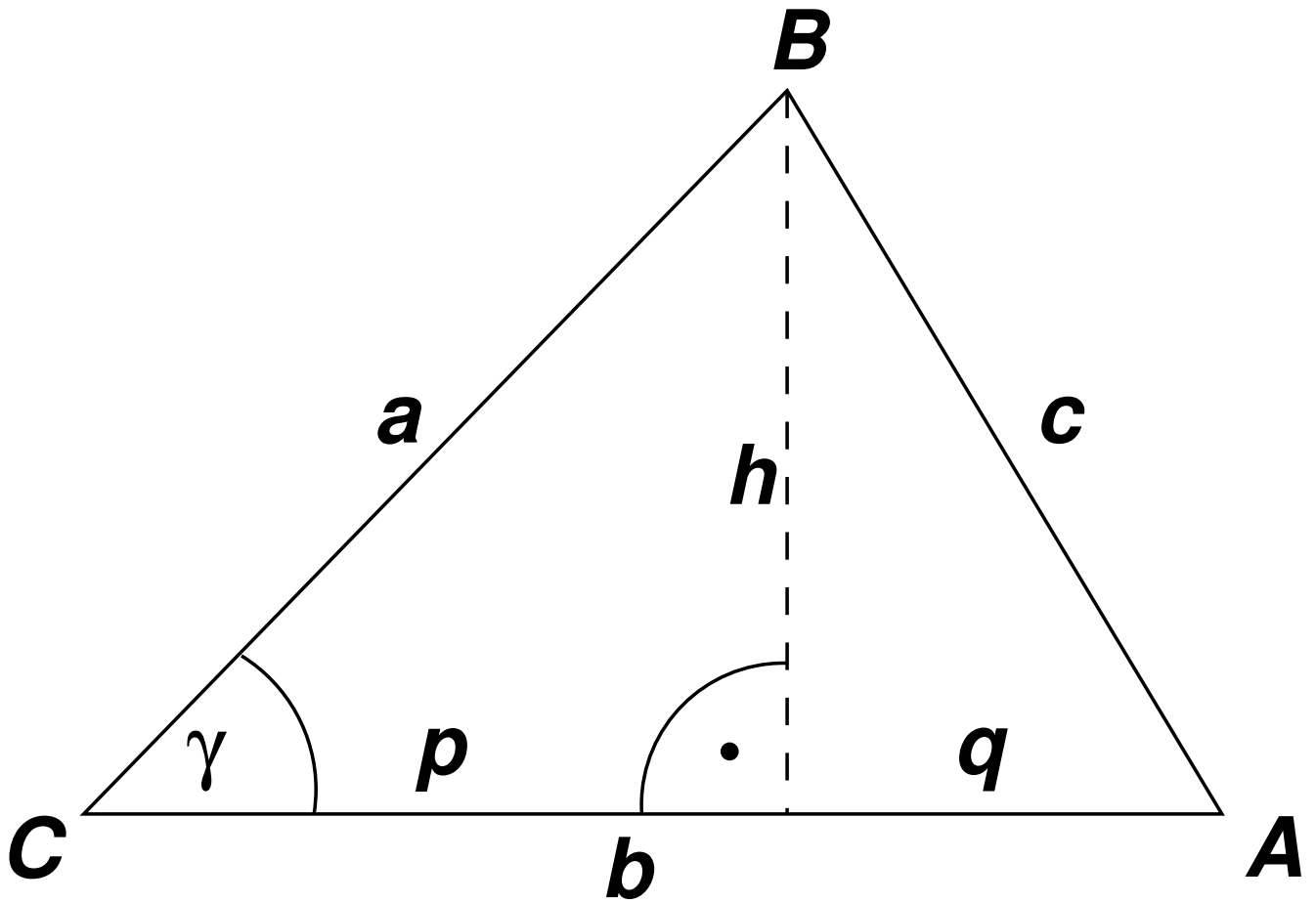

$$c^2 = a^2 + b^2 - 2 \cdot a \cdot b \cdot \cos \gamma$$

Länge der Differenz zweier Vektoren

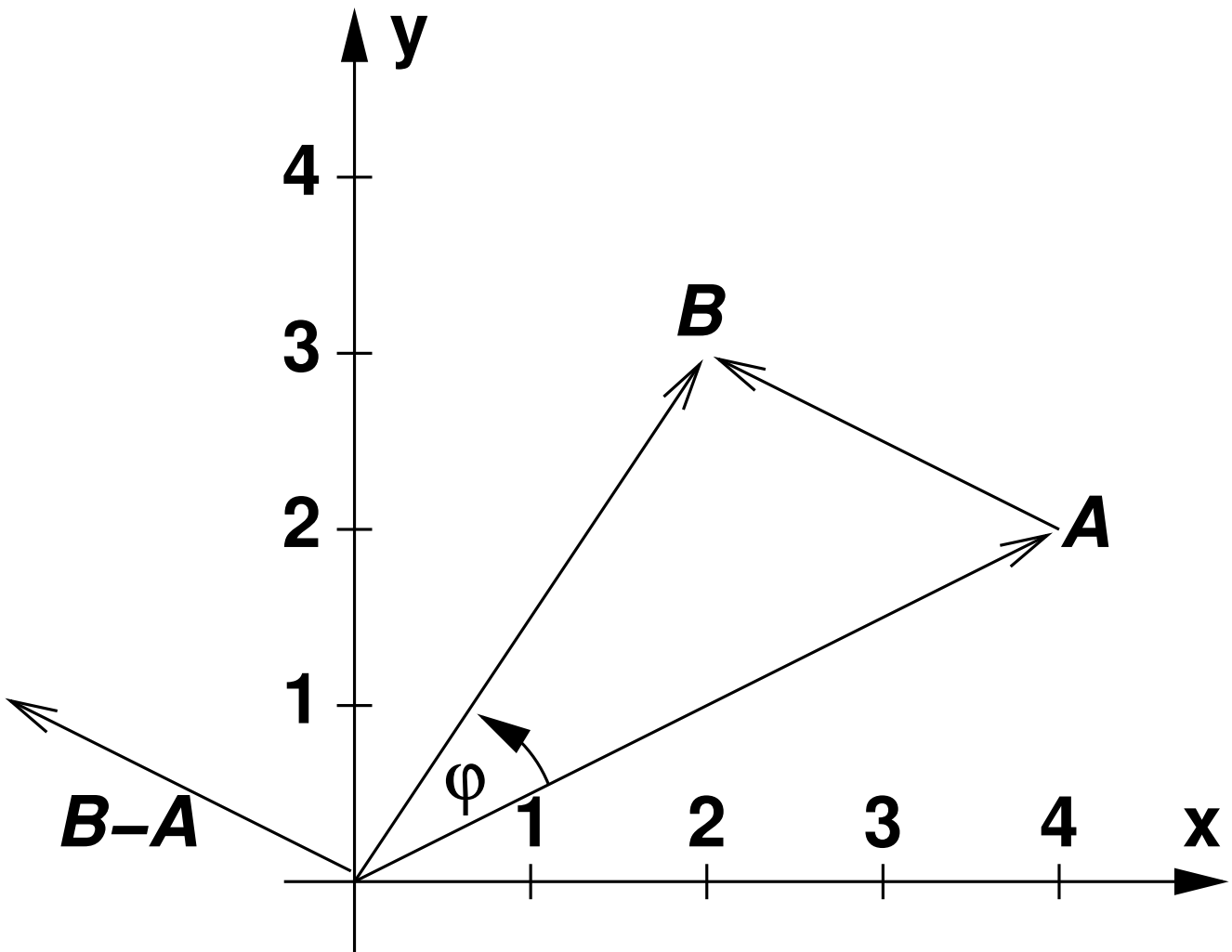

Geometrische Interpretation des Skalarprodukts

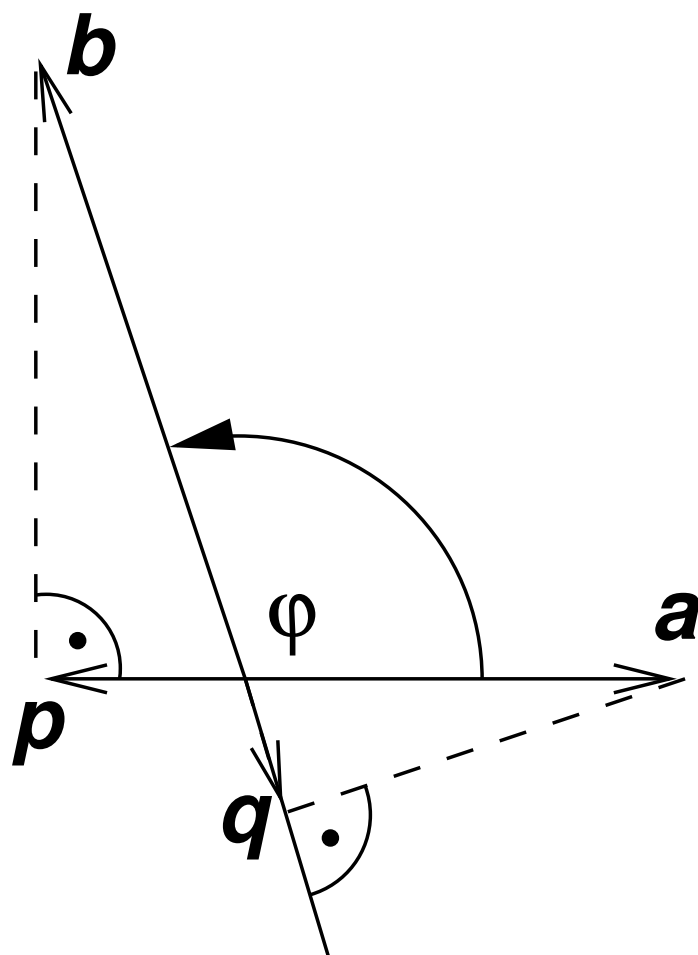
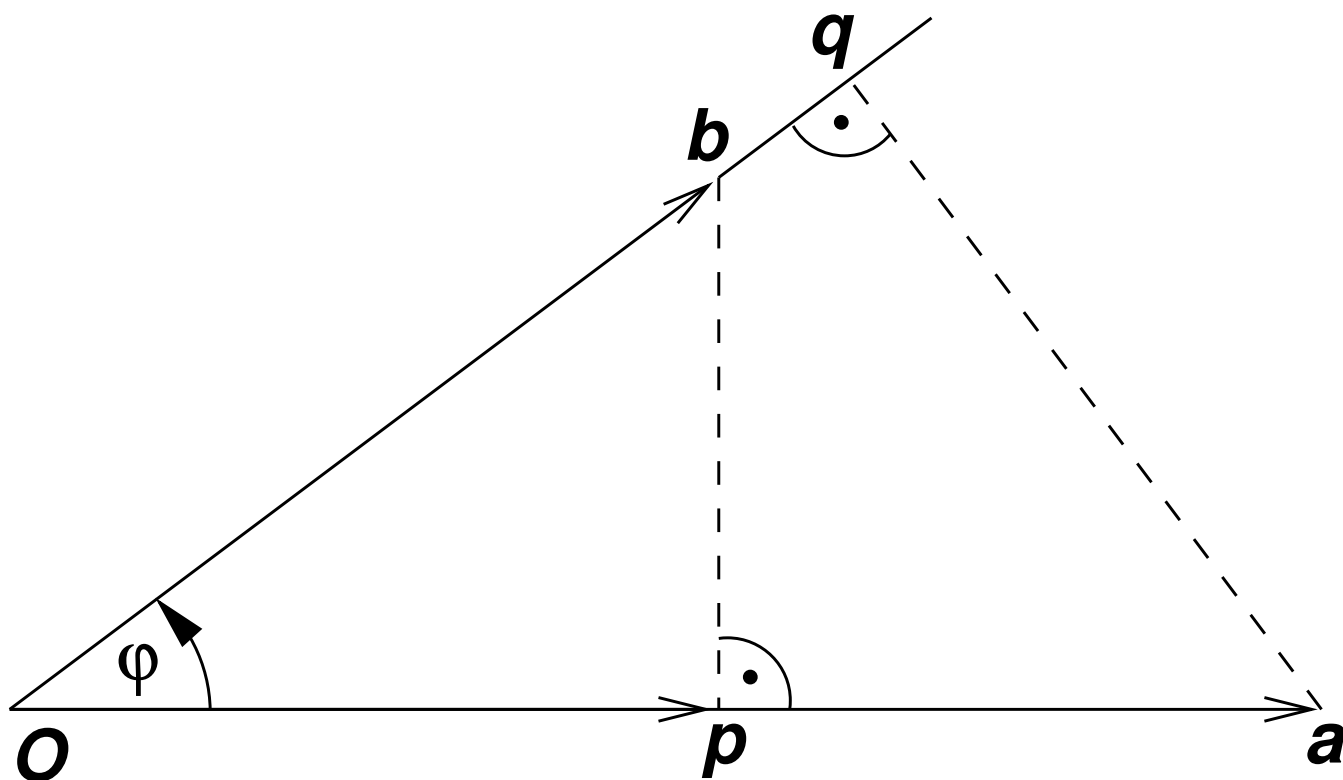

Normalenform einer Geraden in der Ebene

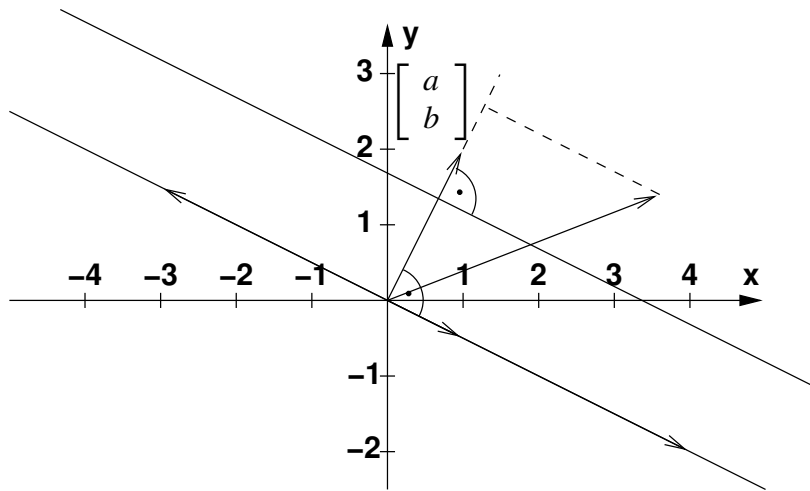

Normalenform einer Ebene im Raum

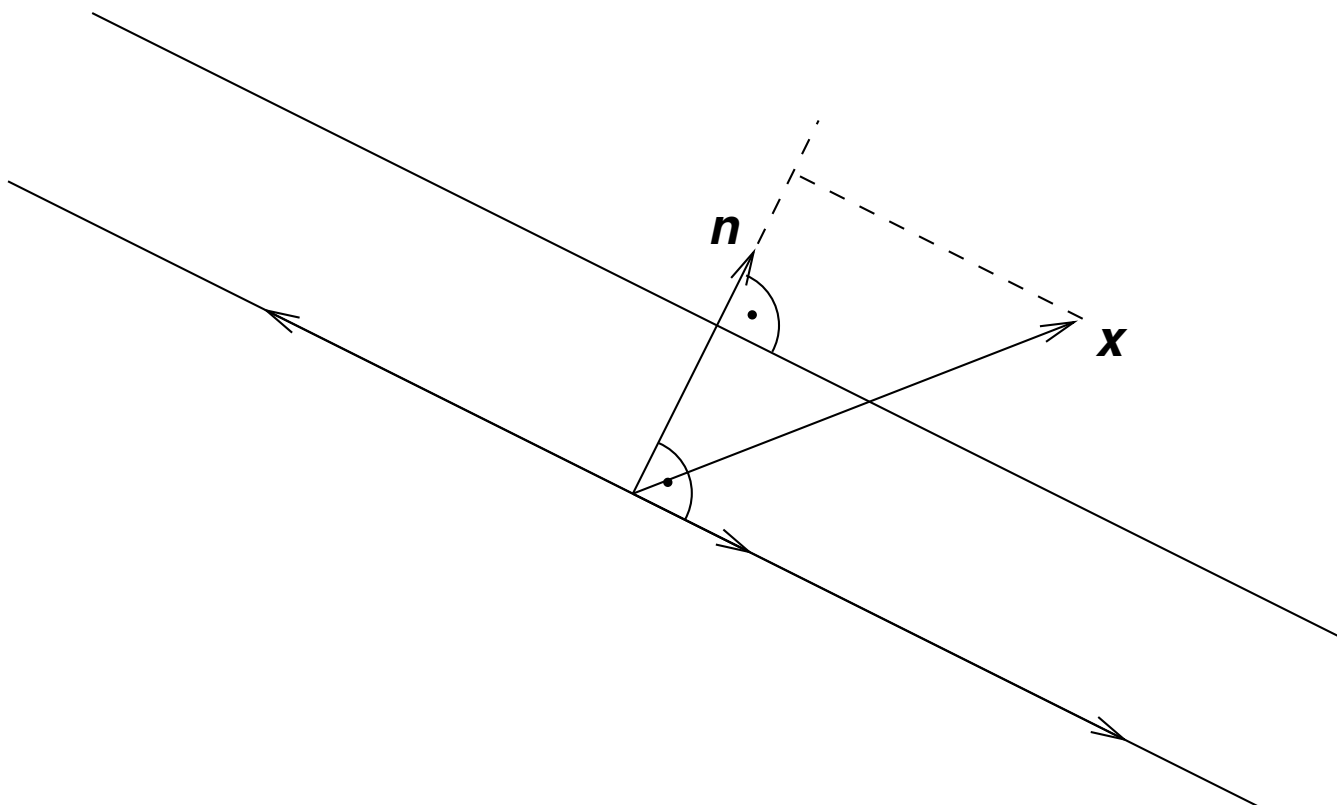

Kürzeste Entfernung von Punkt zu Gerade

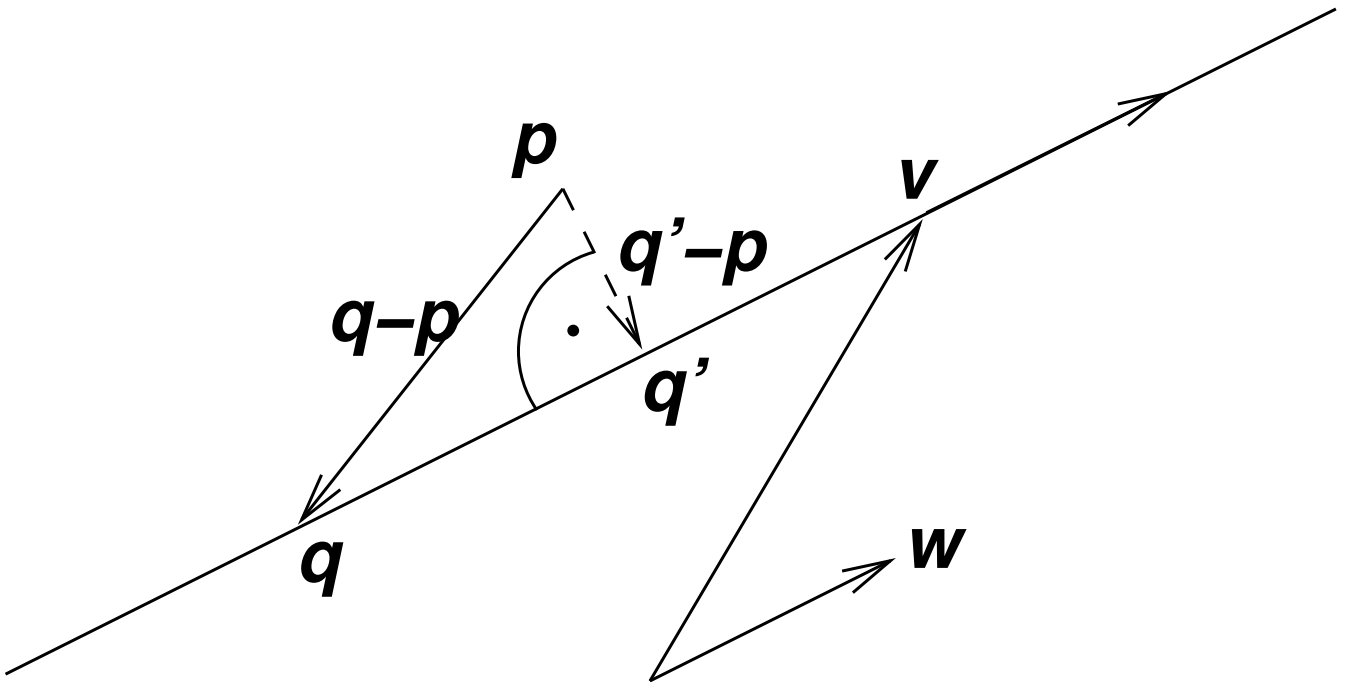

Kreuzprodukt

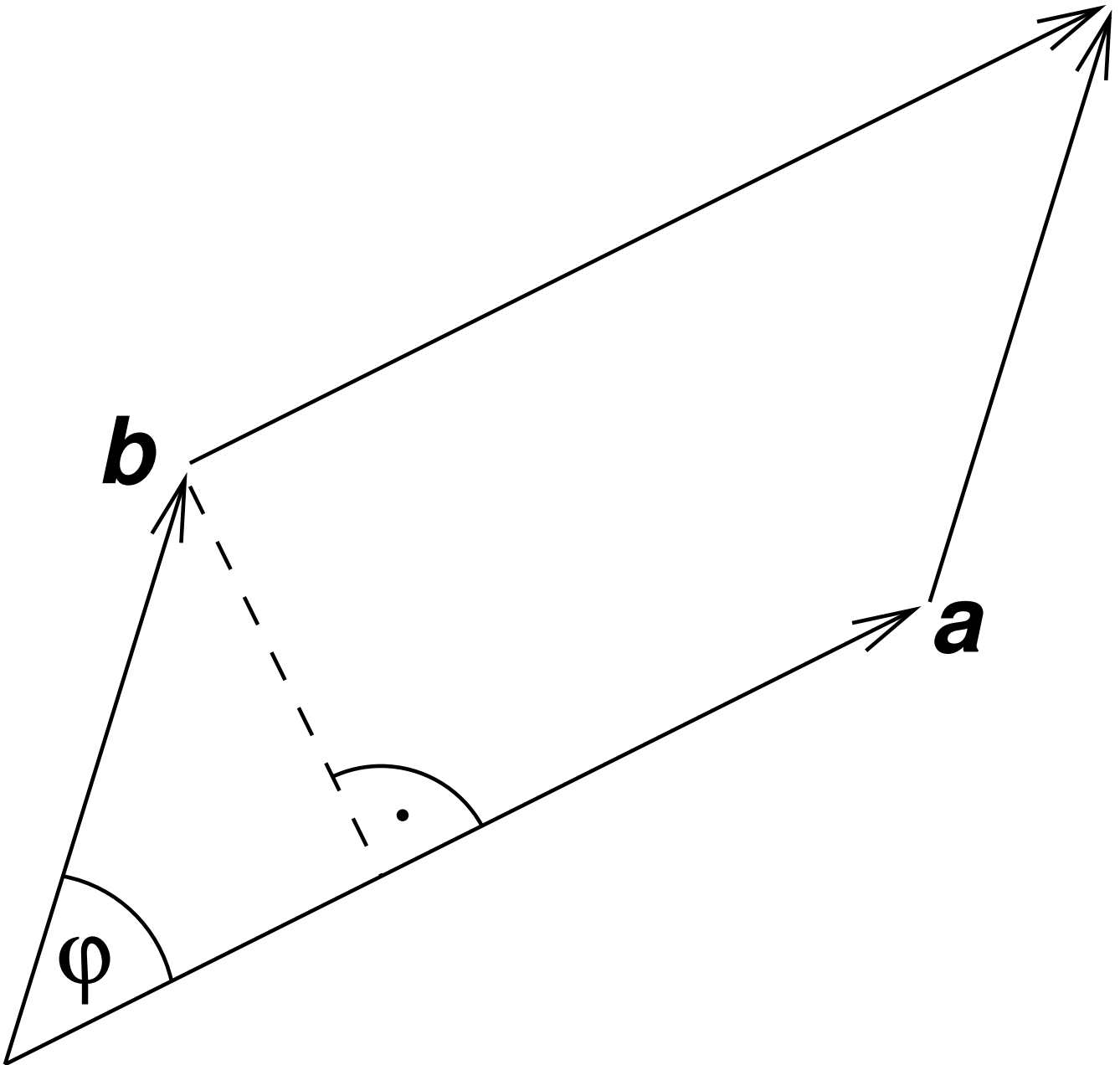

Winkel zwischen Geraden/Ebenen

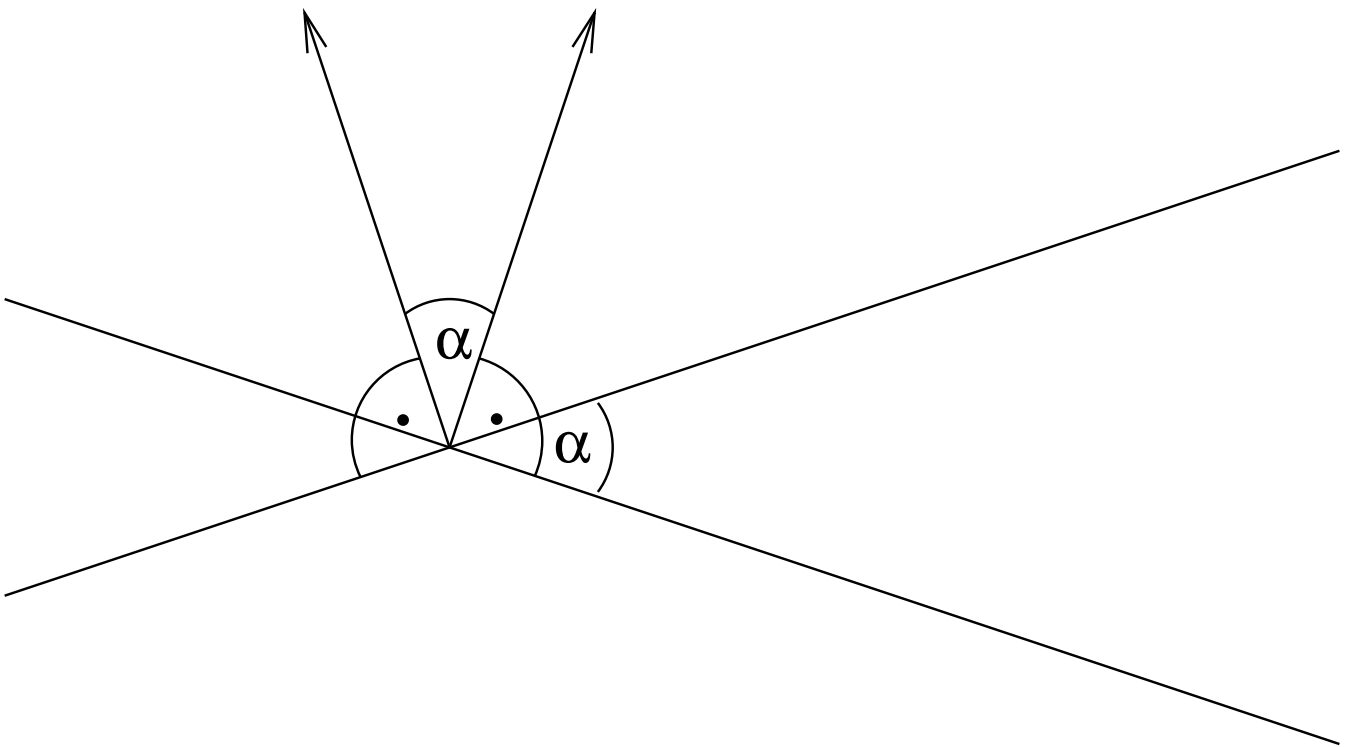

Zentrische Streckung

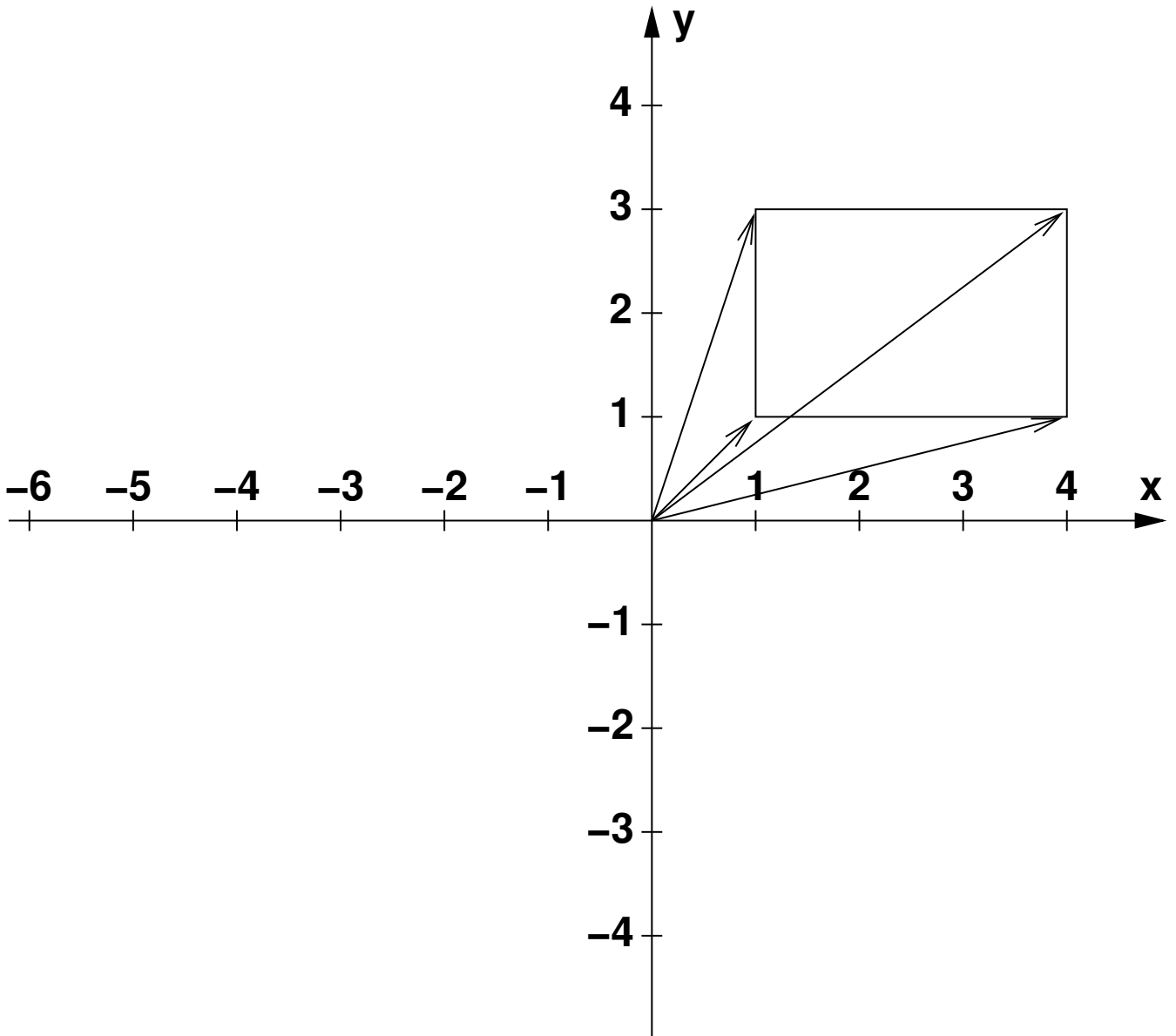

Zentrische Streckung

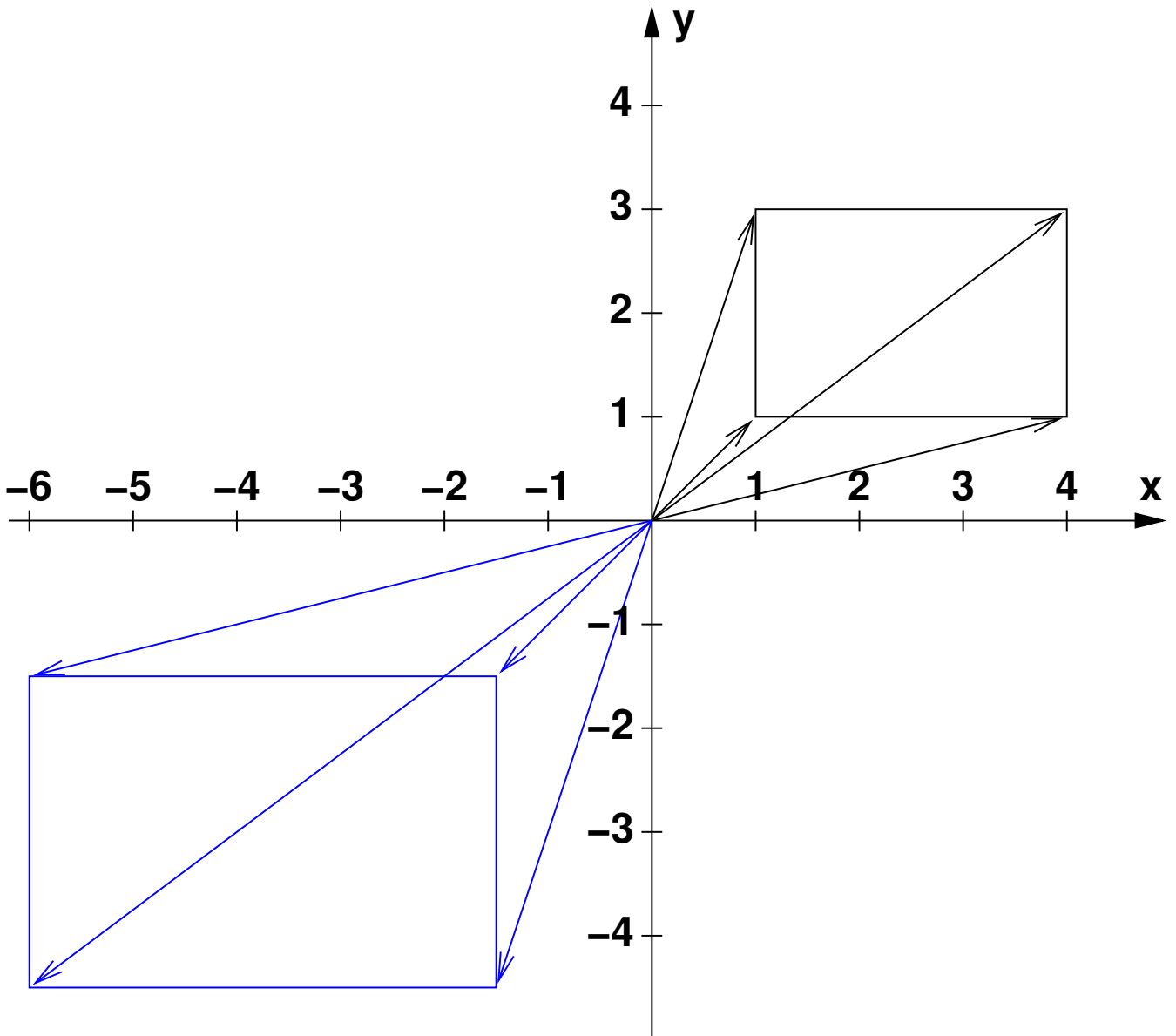

Drehung

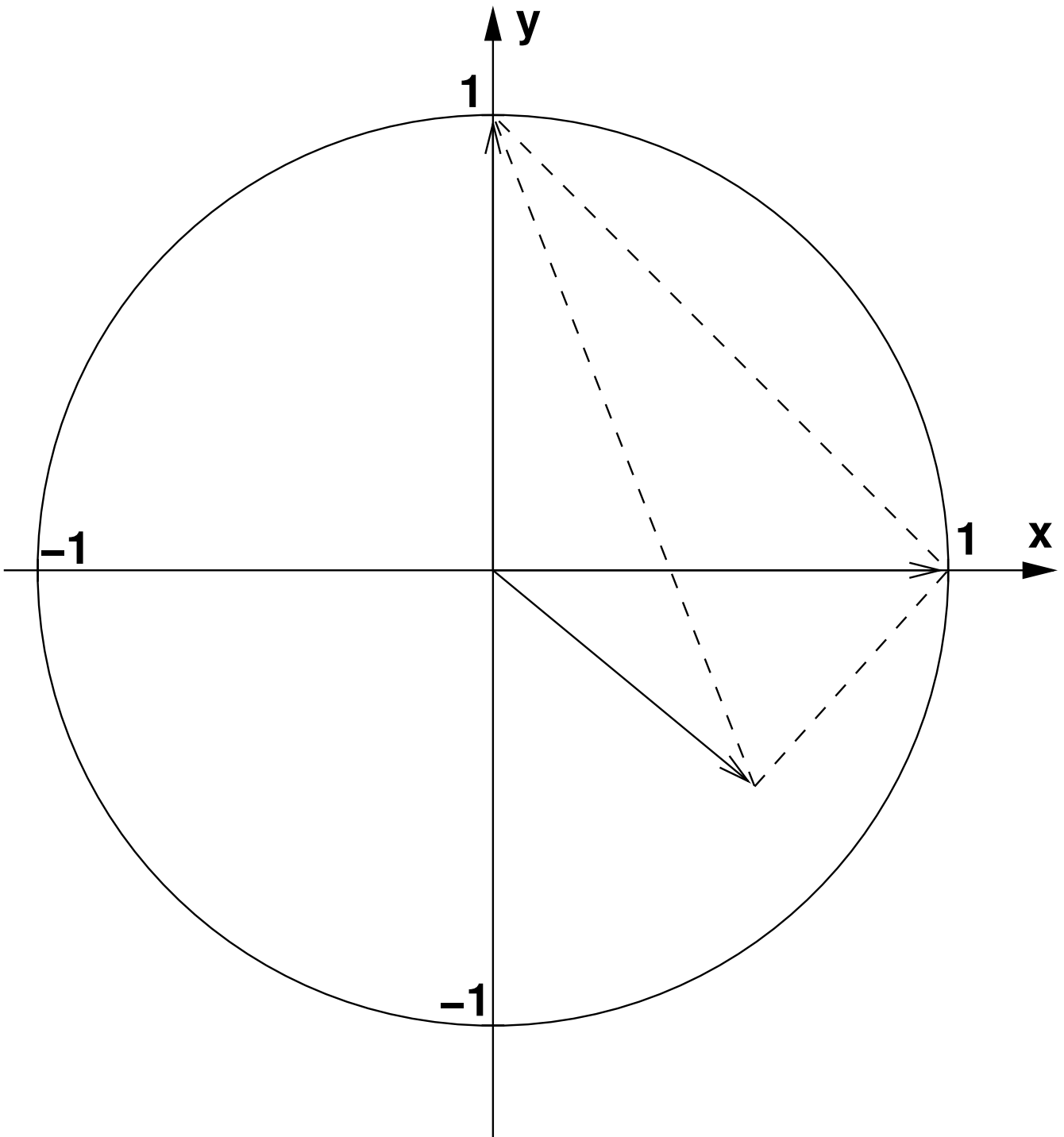

Drehung

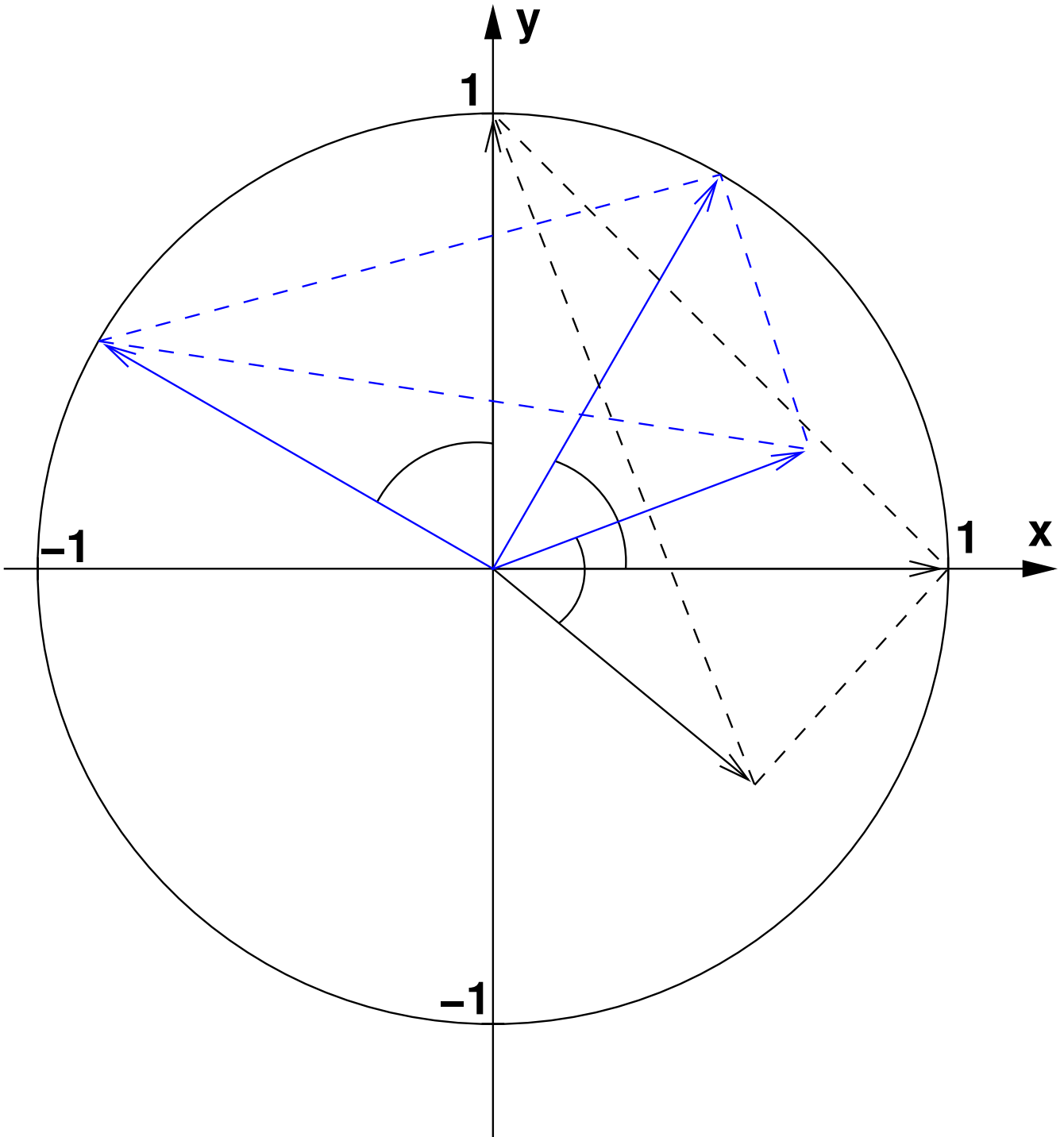

Projektion

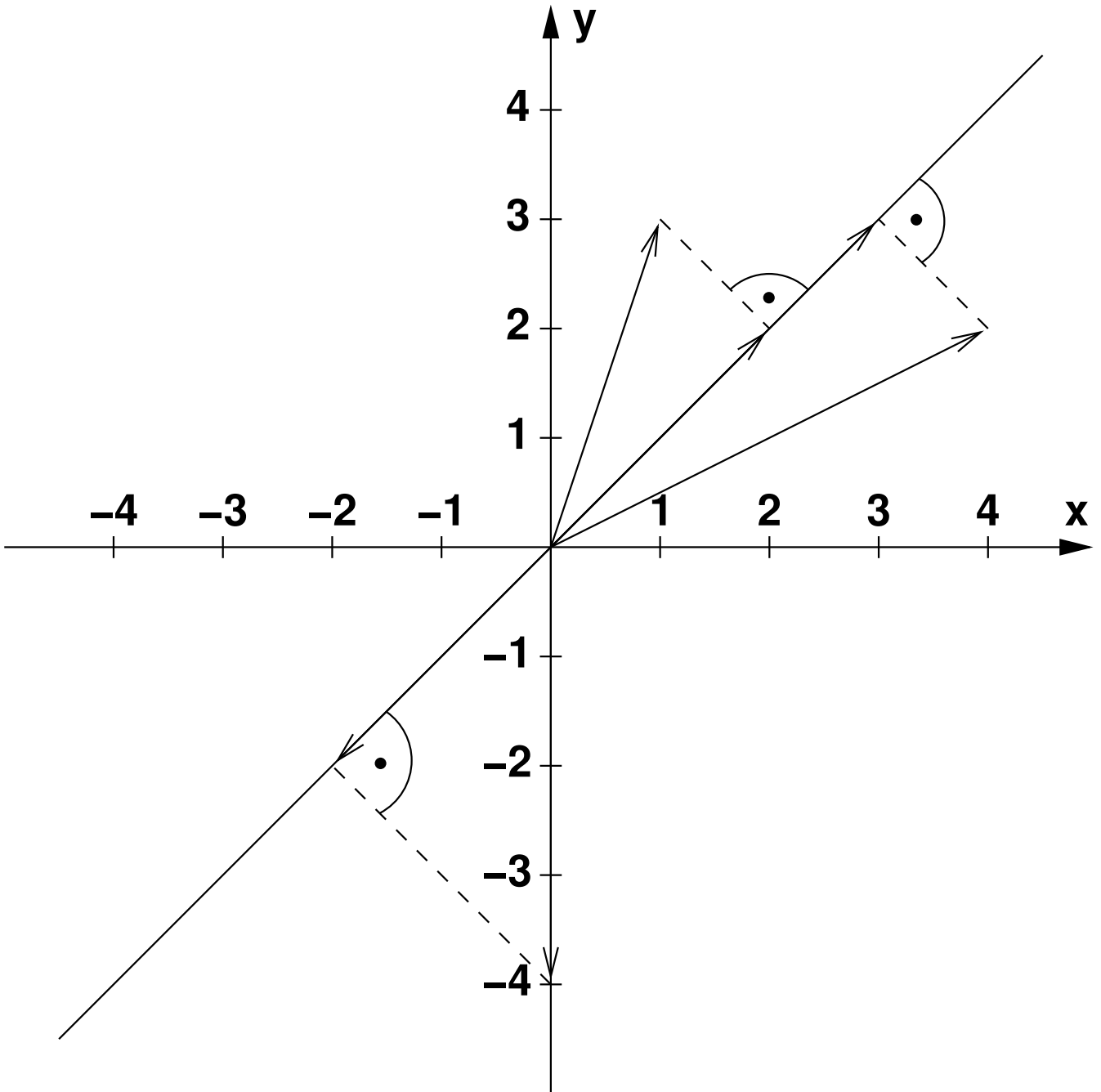

Scherung

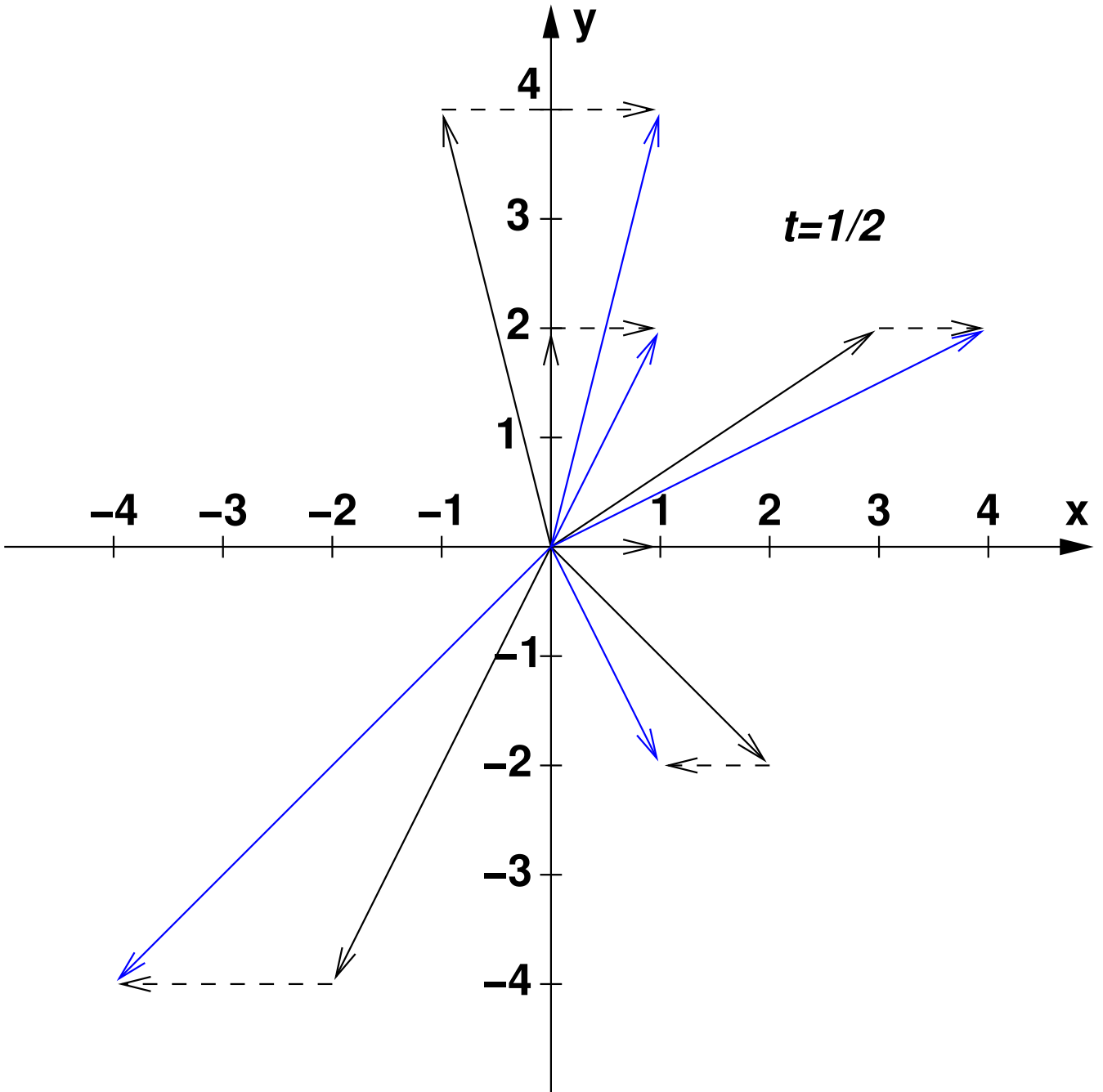

Achsenspiegelung

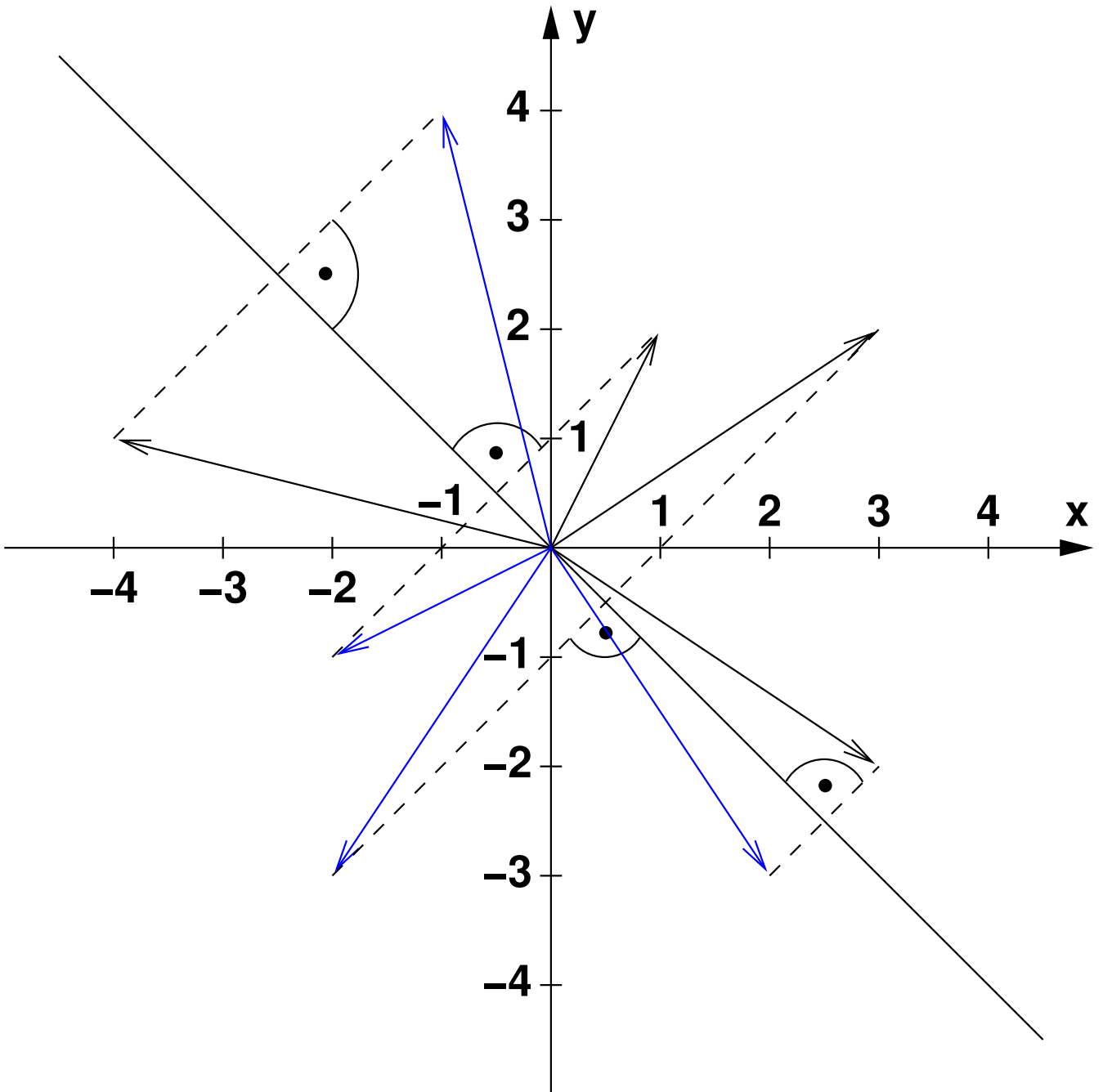

Alle Dreiecke sind gleichseitig!

